

Coated conductors for power applications: materials challenges

This content has been downloaded from IOPscience. Please scroll down to see the full text.

2014 Supercond. Sci. Technol. 27 044003

(<http://iopscience.iop.org/0953-2048/27/4/044003>)

View [the table of contents for this issue](#), or go to the [journal homepage](#) for more

Download details:

IP Address: 158.109.17.16

This content was downloaded on 13/10/2014 at 11:01

Please note that [terms and conditions apply](#).

Coated conductors for power applications: materials challenges

Xavier Obradors and Teresa Puig

Institut de Ciència de Materials de Barcelona, CSIC, Campus de la UAB, 08193 Bellaterra, Catalonia, Spain

E-mail: obradors@icmab.es

Received 25 October 2013, revised 10 January 2014

Accepted for publication 10 January 2014

Published 18 March 2014

Abstract

This manuscript reports on the recent progress and the remaining materials challenges in the development of coated conductors (CCs) for power applications and magnets, with a particular emphasis on the different initiatives being active at present in Europe. We first summarize the scientific and technological scope where CCs have been raised as a complex technology product and then we show that there exists still much room for performance improvement. The objectives and CC architectures being explored in the scope of the European project EUROTAPES are widely described and their potential in generating novel breakthroughs emphasized. The overall goal of this project is to create synergy among academic and industrial partners to go well beyond the state of the art in several scientific issues related to CCs' enhanced performances and to develop nanoengineered CCs with reduced costs, using high throughput manufacturing processes which incorporate quality control tools and so lead to higher yields. Three general application targets are considered which will require different conductor architectures and performances and so the strategy is to combine vacuum and chemical solution deposition approaches to achieve the targeted goals. A few examples of such approaches are described related to defining new conductor architectures and shapes, as well as vortex pinning enhancement through novel paths towards nanostructure generation. Particular emphasis is made on solution chemistry approaches. We also describe the efforts being made in transforming the CCs into assembled conductors and cables which achieve appealing mechanical and electromagnetic performances for power systems. Finally, we briefly mention some outstanding superconducting power application projects being active at present, in Europe and worldwide, to exemplify the strong advances in reaching the demands to integrate them in a new electrical engineering paradigm.

Keywords: coated conductor, $\text{YBa}_2\text{Cu}_3\text{O}_7$, vortex pinning, power applications, nanocomposites

(Some figures may appear in colour only in the online journal)

1. Introduction and overview

More than one hundred years ago, K Onnes, after the discovery of superconductivity, had a dream: that of using these materials to transmit electricity without losses and also to build up magnets with unprecedentedly high magnetic fields. The use of superconducting materials is now widely spread worldwide to generate high magnetic fields in scientific facilities, magnetic resonance spectrometers or magnetic resonance imaging

systems in hospitals, so one of these dreams is now already a reality. The idea of using superconductors in power systems was suddenly revitalized 75 years after K Onnes' finding when high temperature superconductors (HTS) were discovered [1]. Huge progress has been made in the development of HTS materials since their discovery and now different types of conductors based on HTS materials are already a technological reality. On one hand, multifilamentary round wires based on $\text{Bi}_2\text{Sr}_2\text{CaCu}_2\text{O}_8$ and MgB_2 are now commercially available,

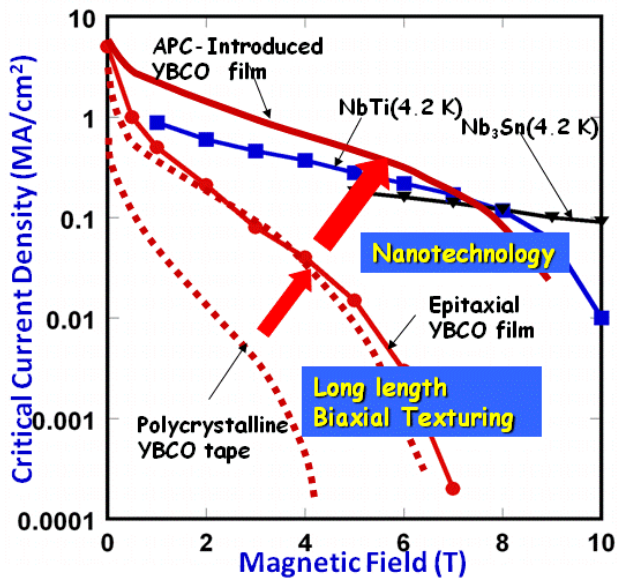

Figure 1. Enhancement of the critical current density $J_c(B)$ measured at 77 K associated with the two big boosts of the coated conductors development: (1) development of the biaxial texture onto metallic substrates and (2) introduction of the nanocomposite structure in the coated conductors. As can be observed, when both advances are combined the performance achieved at 77 K is already above that of NbTi and Nb₃Sn at 4.2 K [15, 16].

on the other hand, tapes with a high aspect ratio based on Bi₂Sr₂Ca₂Cu₃O₁₀ and REBa₂Cu₃O₇ (REBCO, RE = Rare Earth) are also a reality demonstrated in many prototype power systems [1, 2].

While the discovery of HTS materials raised an unprecedented scientific challenge, the development of practical conductors was delayed by the requirement of achieving a practical methodology to surmount the grain boundary problem [3]. It is now understood that the disordered structure at grain boundaries induces charge localization in HTS cuprates having d-wave pairing and this depresses the supercurrent flow [4]. It is therefore compulsory to keep low angles between the grains to achieve high critical densities [5, 6]. The development of second generation (2G) tapes based on biaxially textured YBCO films boosted a huge interest worldwide during the last decade because they raised new opportunities to develop practical conductors for power applications at high magnetic fields and temperatures [7–12]. A completely new frontier was actually definitively opened with these materials, however, through a new scientific breakthrough: the combination of the biaxial structure of the CCs with a nanocomposite structure where non-superconducting nanoparticles or nanorods efficiently pinned vortices at high temperatures [13–18]. This second boost in the development of CCs has definitively positioned these materials as real players in the development of HTS power systems (figure 1).

As a consequence of the technological opportunities opened by CCs, many research programs were established around the world (USA, Japan, Europe, Korea, China) to follow up this new opportunity. As it may be observed in figure 2, the magnetic field–temperature ranges which should

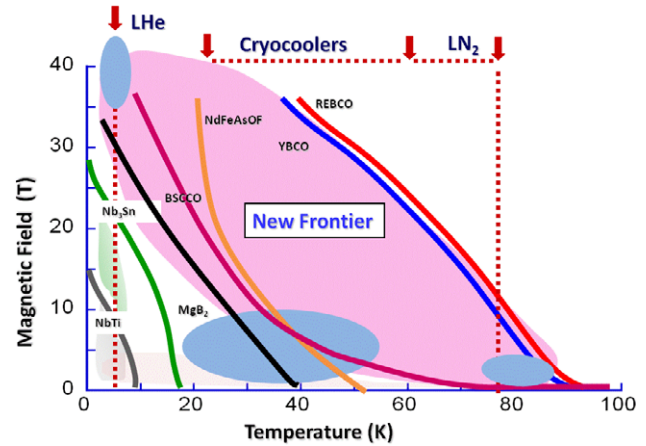

Figure 2. Temperature dependence of the irreversibility field ($H \parallel c$) for different superconducting materials. The new frontier region for the development of applications is indicated together with the three regions where the different power applications and magnets are more likely to occur soon. The temperature regions where the different cryogenic approaches are needed are also indicated [15, 16].

be attainable now with YBCO CCs is much wider than with any other discovered superconducting material, although specific applications are still possible based on other superconductors working at lower temperatures.

An additional cornerstone for a wide propagation of CCs is that of the emerging energy paradigm which is closely related to the need for a sustainable development and a reduction of greenhouse gas emissions [19]. The electrical power system now needs to be made more efficient and prepared for the introduction of renewable generation. As a consequence, a new concept, i.e. the smart grid, has emerged as a result of the link between electrical and electronic technologies [8, 20, 21]. To be successful in the need for such a new electrical engineering paradigm, HTS materials need to demonstrate their capabilities in fully integrated real systems, also including reliable cryogenic cooling. Many different power demonstrators and real systems based on HTS conductors have been built and demonstrated at present and so we can conclude that we are more and more close to the real achievement of K Onnes' first dream.

Several reviews have been recently reported where the advances in CC development and applications were described [7–12, 20, 21]. In all cases it becomes clear that while huge advances have been made in the development of these novel materials, there is still, however, considerable room for improvement and, so, many different types of materials challenges persist. It is, for instance, essential to incentivize the propagation of the CC use in power systems to reduce the CCs cost/performance ratio which is usually measured in terms of $\text{€ kA}^{-1} \text{m}^{-1}$ for a conductor 1 cm wide. These metrics should be measured under the corresponding working conditions of the systems (for instance, 77 K and self-field or 30 K and 3 T). On the other hand, to quantify the progress in scaling up the manufacturing of CCs, the $I_c \times L$ product is usually looked at, where L is the total length of the produced conductor and I_c is the end-to-end critical current at 77 K at self-field. In this review we will focus on the description of

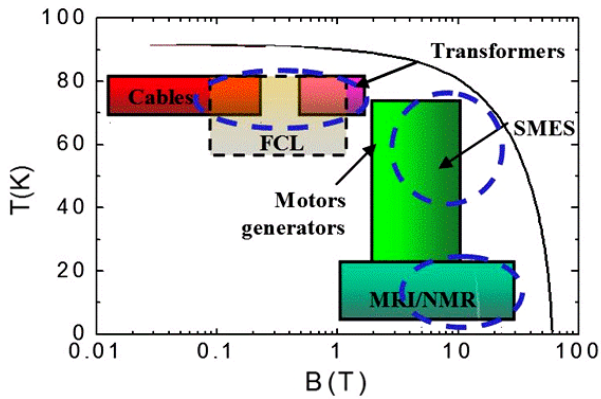

Figure 3. Operating magnetic fields and temperatures where the YBCO coated conductors have performances (critical currents or pinning forces) adapted to the different indicated applications. Three targeted regions of the EUROTAPES project are highlighted.

the most recent materials development advances, as well as on describing the challenges we are facing at present worldwide, with a particular emphasis on the efforts being made in Europe.

Europe closely followed the international trend and diverse R+D efforts were established in CC development, both at the national levels and through international cooperation projects supported by the European Union. The largest European project related to superconductivity ever launched was only recently initiated: 'European development of Superconducting Tapes: integrating novel materials and architectures into cost effective processes for power applications and magnets'. The project involves 20 partners from nine countries [22].

The final objective of the project is to deliver long lengths (+500 m) of CCs at pre-commercial costs ($\sim 100 \text{ € kA}^{-1} \text{ m}^{-1}$) and to select the most promising technological choices for power applications. Three ranges of magnetic fields were targeted which require to use the tapes working at different temperatures (figure 3). First, the low magnetic field range ($< 1 \text{ T}$) is suitable for cable and FCL systems which could work at around 77 K . Second, a high magnetic field range ($3\text{--}5 \text{ T}$) which at present would require placing the CCs at temperatures in the range of $30\text{--}60 \text{ K}$ to achieve high enough critical currents. Power systems which could be generated with these conductors would be mainly rotating machines and SMES. Finally, ultra-high magnetic fields ($> 15 \text{ T}$) to build magnets could only be achieved cooling at lower temperatures ($\sim 5 \text{ K}$).

Additionally, the strategy of the project also takes into account that the required conductor lengths for each power application, and so also the fraction of HTS wire relative to the total system cost, deeply differs. For instance, while in magnets the wire cost is in the range of $5\text{--}15\%$, in transmission-distribution systems (cable, FCL, transformer) typically the wire cost rises to $20\text{--}25\%$ of the total cost. In rotating machinery the wire cost could be also as high as 30% of the total system cost. This wide span of cost relevance forces the need for developing different conductor architectures, having different production costs, and so it is advisable to investigate the different types of CCs characterized by specific

performances under the corresponding working conditions and allowing to achieve a certain spread in the final production costs.

2. Coated conductor architectures

The colossal 'tour de force' for materials scientists to develop CCs is summarized in the schema shown in figure 4 where it is visualized how many relevant parameters need to be combined in unique ways to achieve high performance while cost-effectiveness also should be enhanced. At present complex conductor architectures are the main choice in commercial CCs (with multiple buffer layers) in order to tackle globally with the divergent required features. Many alternative modified combinations are being investigated worldwide at present and all of them have actually some advantages and some drawbacks. In any case, a huge progress has been made worldwide in increasing the length and performances of CCs produced at an industrial basis, as it can be seen in figure 5 where the product $I_c \times L$ is indicated as a function of the years. This figure shows that the industrial leadership has been reached based on different types of substrates (RABiT and IBAD) and deposition techniques (PLD, MOCVD, CSD) in USA (AMSC, Superpower) and in Japan (ISTEC, Fujikura, Sumitomo, Showa). A particular outstanding recent development is also that based on the so-called Reactive co-evaporation by deposition and reaction (RCE-DR) approach by SuNAM (Korea), where very fast conversion rates are achieved when an amorphous to crystalline transition is induced by a change in oxygen pressure (PO_2).

EUROTAPES explores essentially two architectures which combine the best knowledge existing in Europe in diverse and complementary areas: metallic substrate production, vacuum and chemical deposition methods and advanced microstructural and physical characterization. Scientific knowledge on metallurgical development, epitaxial growth, solution chemistry, surface chemistry, colloidal chemistry, film nanostructuring and manufacturing methodologies, including *in situ* quality control tools, will be used to select the best conductor architectures and processing methods for CCs industrial production (figure 6). A scheme of the main conductor architectures to be investigated is shown in figure 7.

The RABiT approach based on NiW alloys is now already a commercial success being used by several companies worldwide. However, new developments are still required to decrease the ferromagnetic behavior of these substrates. EUROTAPES will investigate this issue relying both on the search for new non-magnetic substrates (Ni and Cu based) and in increasing the W content in the NiW alloys. The final goal is to reduce ac losses and in the case of new Ni or Cu-based substrates, novel buffer layer combinations need to be investigated having, as a final objective, to achieve high performances at low cost based mainly on CSD methodologies. On the other hand, polycrystalline metallic substrates (SS) will also be investigated using ABAD as a route to produce textured templates. The main oxide to be investigated is YSZ, a robust template widely used by Bruker HTS, but also the capabilities of TiN as a template layer will be explored.

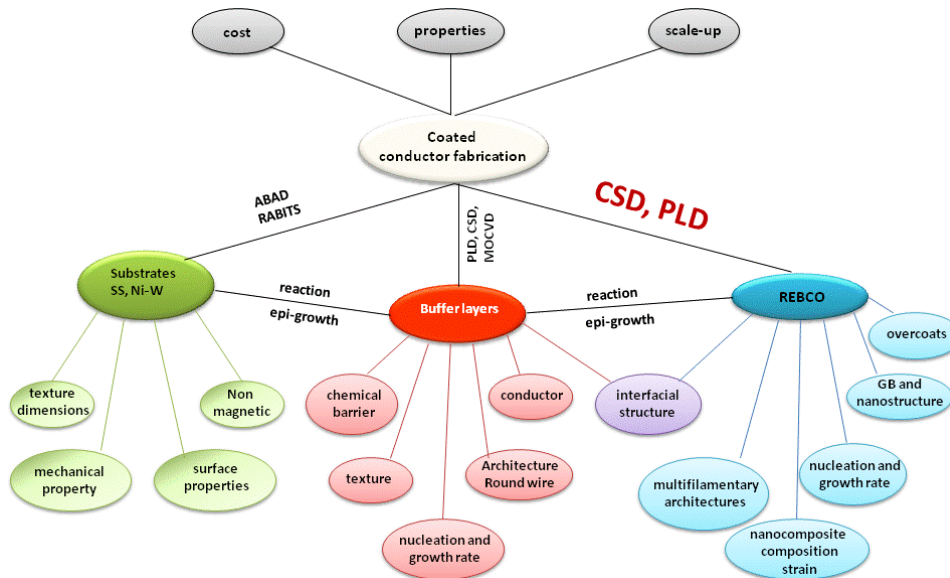

Figure 4. General layout of the scientific and technological issues involved in the development of coated conductor production. The challenge in coated conductor development is to properly consider all these issues to achieve an integrated approach for a successful manufacturing process.

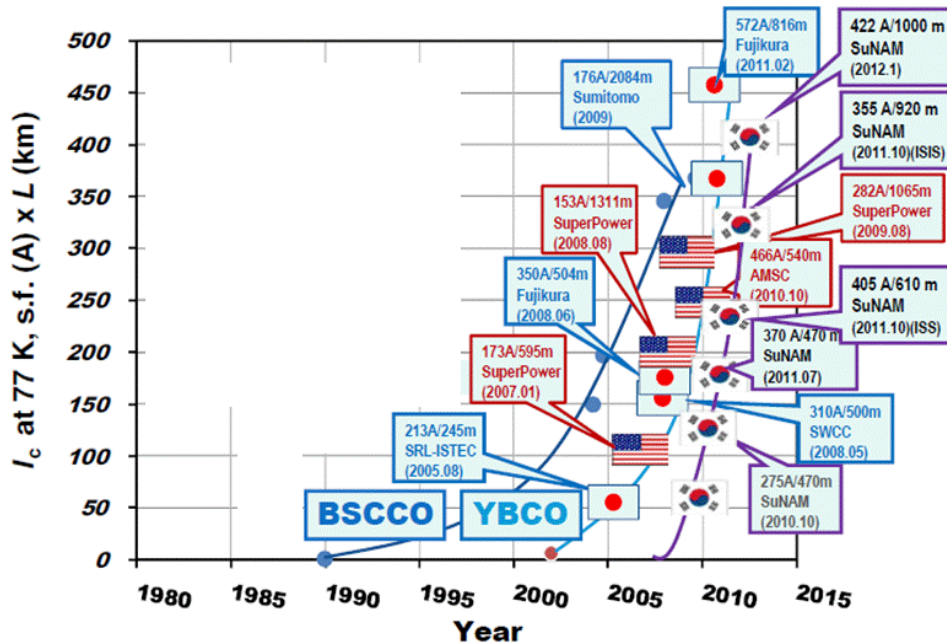

Figure 5. Progress in the development of long length manufacturing of coated conductors. The best values of the product $I_c \times L$ (total critical current \times conductor length) for a CC 1 cm width are indicated versus the year where they were achieved [8].

In both cases a particular effort will be made to develop methodologies intended to reduce production cost, such as solution deposition planarization (SDP) [23] which minimizes the need for polishing the metallic substrate, as well as in growing buffer layers by CSD. Finally, the potential of one new conductor architecture will also be examined within the consortium, i.e. that of round wires based on 2G tapes. The interest of this geometry relies on its practical interest for the fabrication of power cables where the use of space should be optimized at the same time that manufacturing is simplified, as demonstrated by Nexans [24]. Summarizing, in figure 8 we

display the different CC combinations that are being explored as potential industrial enablers, either within EUROTAPES or by other European players.

3. Metallic substrates and buffer layers

As we have mentioned above, two different types of metallic substrates are worthy of being considered for a full development of CCs. On one hand, polycrystalline metallic substrates support an oxide template textured through IBAD. This is done in Europe by Bruker using SS with YSZ biaxially

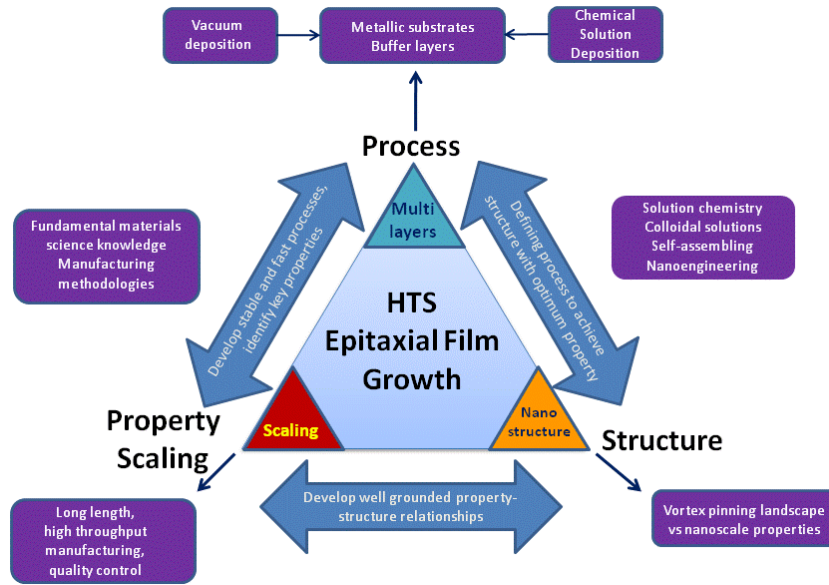

Figure 6. The core of coated conductor development is the scientific knowledge on epitaxy and nanostructure development and the main challenge is to properly implement in an integrated way the techniques to prepare multilayered materials and nanocomposites adapted to metallic substrates. The EUROTAPES strategy is to combine the best vacuum and solution chemistry based thin film deposition approaches in order to manufacture long lengths of CCs with a high yield at a high throughput.

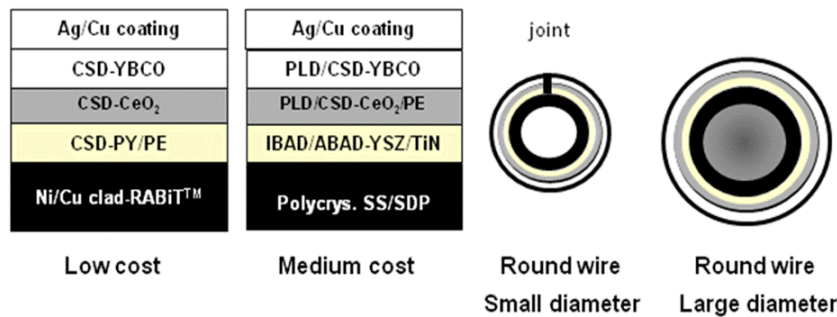

Figure 7. Sketch of the three types of conductor architectures envisaged for development within EUROTAPES. Low cost CC consist of RABiT substrates combined with an ‘all chemical’ deposition approach. Medium cost CCs are based on IBAD/ABAD templates on top of polycrystalline SS substrates, eventually coated with an amorphous oxide layer to planarize the substrate (solution deposition planarization, SDP).

textured templates grown by a modified ion beam deposition approach (alternating beam assisted deposition, ABAD) in lengths exceeding up to 280 m at present [25] (figure 9). This templated metallic substrate is being used as the basis for a high rate PLD (HR-PLD) growth approach followed by Bruker (CeO₂ and YBCO layers) [26] and also by ICMAB and Oxolutia for its approach based on CSD deposition using ink jet deposition (IJD) of the cap layer (Ce_{1-x}Zr_xO_{2-y}, CZO) and the superconducting YBCO layer [27–29]. Typical thicknesses of ABAD-YSZ layers are 1.0–1.5 μm while those of CeO₂ and CZO are 50 and 20 nm, respectively. An appealing feature of this metallic substrate is its high mechanical strength and the robustness against high temperature annealing conditions (for instance CZO growth can be performed at 900 °C in oxygen atmosphere). In both cases the final texture quality of the cap layer is fairly good, as well as the surface planarity (> 70% and rms roughness ~1.2 nm) which is strongly improved even with very thin CZO films, and thus the substrate is perfectly suited

for long length deposition and growth of YBCO layers [26, 27]. To develop suitable biaxial textures in ABAD-YSZ requires larger film thickness than other counterparts, such as MgO or Gd₂Zr₂O₇ [23, 30], but on the other hand the process is less sensible to surface roughness of the substrate. It would be worthwhile, therefore, to define strategies to reduce ABAD deposition time and production cost through the use of solution deposition planarization (SDP) and to extend the substrate width above 40 mm. The technique of SDP has been found to be useful in the case of IBAD deposition of MgO on Hastelloy because it reduces the environmental concerns of the chemicals used in the polishing process but its suitability for YSZ on SS is still to be analyzed.

The attractive potential of an additional IBAD alternative, TiN layers, has been recently demonstrated (figure 10) using buffers and YBCO layers grown by PLD [31, 32] but it is still to be investigated if it can be combined with the SDP process. In the scope of EUROTAPES this compatibility

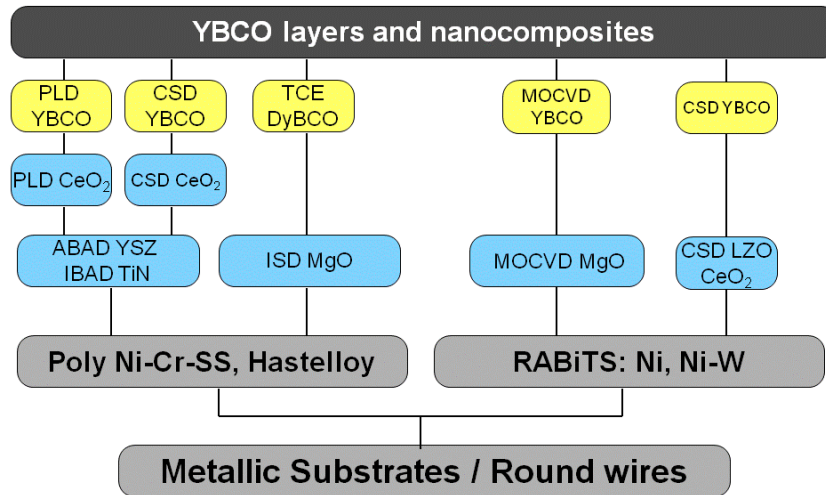

Figure 8. Schema of the main coated conductor architectures being developed at present within Europe, including both those being investigated within EUROTAPES and by other industrial companies.

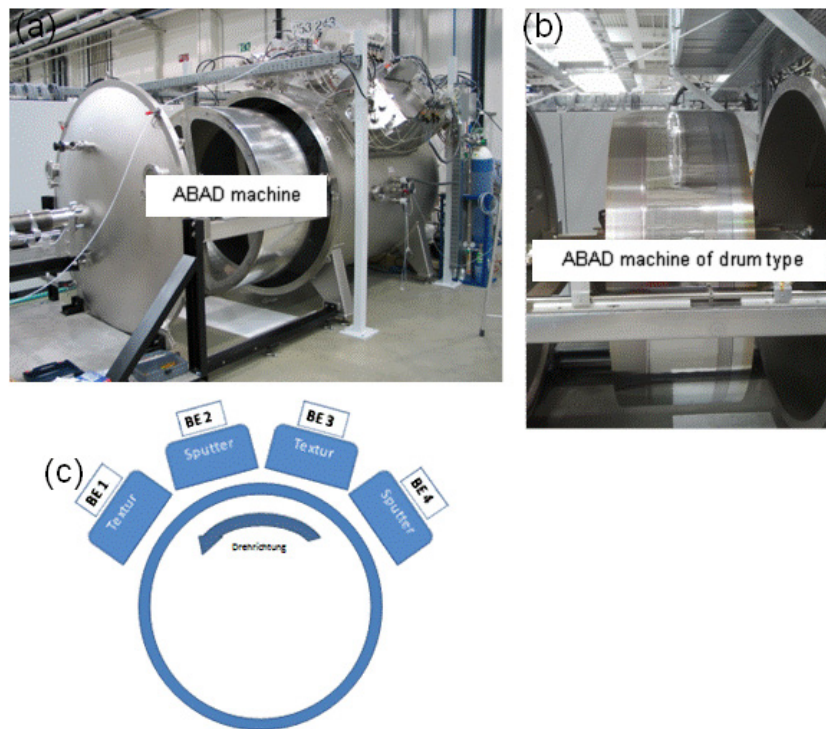

Figure 9. (a) and (b) External views of the drum equipment to produce YSZ-ABAD templates on SS substrates at Bruker. (c) Schema of the rotating drum where the metallic substrate is located and the geometrical arrangement of the sputtering and ion guns.

will be investigated because it appears as a new appealing opportunity to reduce deposition cost due to the small thickness required to achieve highly textured films in this case, similarly to MgO IBAD layers [23, 33]. Growth of several oxide buffer layers by CSD (perovskites, MgO) will be investigated to find a suitable multilayered structure for this novel conductor architecture.

The second option as metallic substrate is based on the RABiT approach. Commercial production of Ni9%W is already available and so several CC producers use these textured substrates [34, 35]. This substrate forms the basis for

most studies of multilayered growth in this area. A desirable objective is, however, to make available non-magnetic substrates allowing to reduce ac losses. Here the simplest approach is to achieve highly textured Ni9%W substrates where the ferromagnetic properties are deeply weakened (low Curie temperature, reduced magnetization) and so the ac losses reduced (figures 11(a) and (b)) [36]. This issue has already been investigated in Europe and so the scalability of the process will be further developed [34]. An open issue that also needs further research is how to define appropriate S surface templates on RABiT substrates to control the buffer layer nucleation

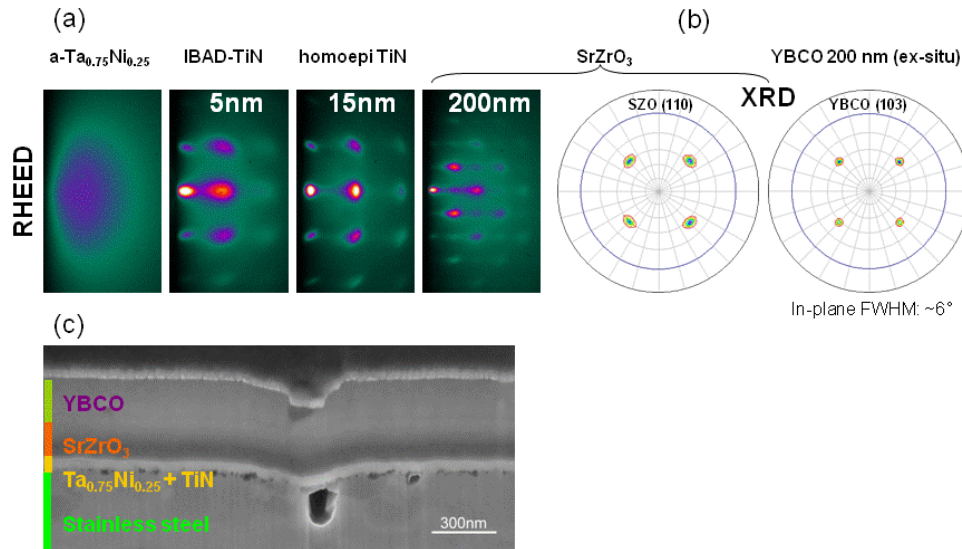

Figure 10. (a) RHEED patterns of the different layers grown in the TiN-IBAD approach: amorphous $\text{Ta}_{0.76}\text{Ni}_{0.26}$, TiN-IBAD layer, homoepitaxial TiN layer and SrZrO_3 buffer layer; (b) x-ray diffraction pole figures of the SrZrO_3 buffer layer and the YBCO layer grown on top of the biaxially textured IBAD template; (c) FIB cross section of the full conductor architecture [31].

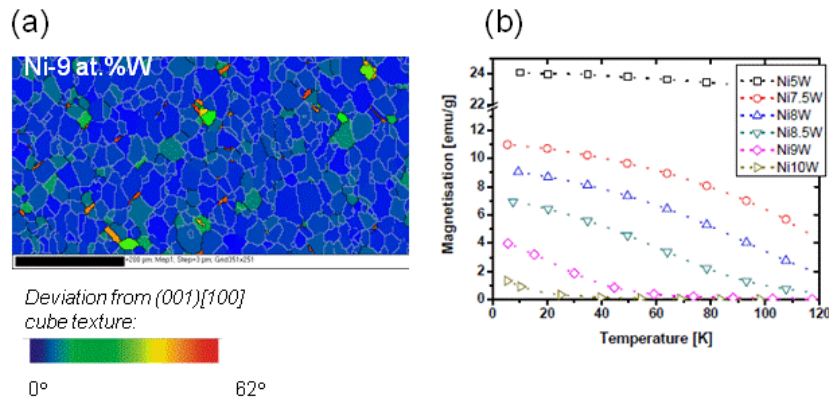

Figure 11. (a) EBSD map of a Ni-9 at.%W RABiT substrate where the local angular deviation from cube orientation is visualized [35]; (b) magnetization as a function of temperature in NiW alloys with different contents of W [36].

process. CSD growth of buffer layers on RABiT substrates has been widely explored; however, further understanding of the nucleation and growth processes is still needed [37], as well as to define the best processing methodologies to reach a low surface roughness and high quality multilayered structure [38–40]. So new oxide phases will be searched for which could simplify the CC architecture as well as new shortened processes which could lead to enhanced performances (surface planarity, film thickness for efficient protection, etc).

The main players involved in the search of improved buffer layers for NiW RABiT substrates based on CSD approaches will also widely explore the capabilities of using IJD as a reliable industrial approach to produce robust buffer layers for these metallic templates and to reduce the total cost through selection of the simplest architecture [41]. Several oxide phases will be thoroughly tested, pyrochlores ($\text{La}_2\text{Zr}_2\text{O}_7$), fluorites (CeO_2), rock-salt-like structures (MgO), etc. The final goal of this research is to select simplified architectures, develop robust processing methodologies and to implement them on long length manufacturing of RABiT templates using IJD [41, 42].

Within the scope of searching for non-magnetic RABiT substrates, it is also worth analyzing the suitability of using Cu-based substrates mechanically reinforced through a cladding process or Cu alloys [43]. The suitability of these alternatives requires finding adequate buffer layer structures. It will very likely be necessary to combine the know-how on PVD and CSD approaches to overcome the expected difficulties. The advantage of these metallic substrates lies, besides its non-magnetic behavior, on the high quality of the texture for wide substrates and its lower cost. However the development of robust protective buffer layers is quite demanding due to the high oxidation power of Cu [44–46].

Both ABAD and RABiT based metallic substrates are in principle suitable for the round wire production mentioned before which should achieve medium performances to be used for cable wiring. The present cable designs based on CCs have a complex coaxial architecture where copper wires form a core while around it are wrapped the superconducting tapes and the corresponding dielectric layers and all the ensemble is contained within a vacuum-jacketed cryostat [24].

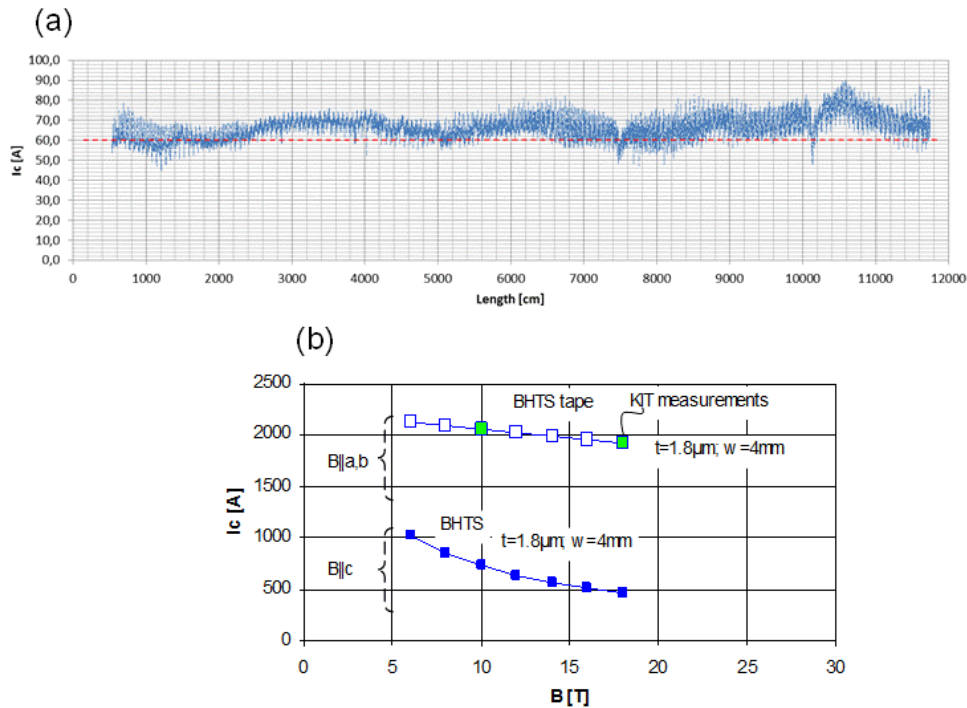

Figure 12. (a) Homogeneity of the critical current in a CC produced at Bruker by PLD on $\text{CeO}_2/\text{YSZ}/\text{SS}$ substrates; (b) magnetic field dependence $I_c(B)$ measured at 4.2 K with two magnetic field orientations for a CC with a YBCO thickness of 1.8 μm and a width of 4 mm [51].

The novel idea of using round wires to replace the Cu core in cables has become possible owing to the fact that the fragile YBCO ceramic layer is accurately placed on the neutral axis of the tape where there is minimal tension during bending. This development requires considering in detail several issues related to the development of a welding process, accurate wire tooling, the deposition and stability of buffer and superconducting layers, electrical and thermal protection, mechanical properties and ac losses, etc. All types of available CCs will be tested for the purpose of these analyses.

4. Superconducting layers

Growth of superconducting layers and optimization of their properties is definitely the core technology in CCs. For many years, a large number of groups worldwide have devoted much effort in demonstrating the feasibility of using these layers to transport large currents and several growth techniques have emerged as the most promising [7, 8, 10–12, 47, 48]. In Europe two key technologies have a large tradition and they are foreseen to be widely investigated, pulsed laser depositions (PLD) and chemical solution deposition (CSD), although some effort based on evaporation (EV) and MOCVD is also being made [49, 50]. In all cases, YBCO and GdBCO, or mixed RE ions such as (Gd,Y)BCO, are being considered as attractive superconducting phases. In the particular case of EV layers the growth of the REBCO layer is being carried out on MgO textured buffer layers grown by inclined substrate deposition (ISD), an approach where the REBCO layers are inclined with respect to the substrate. Based on this approach, film thicknesses as high as 7.5 μm and $I_c > 1000 \text{ A cm}^{-1} \text{ W}^{-1}$ at 77 K have been demonstrated [49].

Reel-to-reel CC production is made by a multiphase HRPLD by BRUKER on YSZ ABAD-templated SS substrates [26]. CCs with lengths in excess of 280 m and with $I_c = 250 \text{ A cm}^{-1} \text{ w}^{-1}$ have already been achieved with good homogeneity (figure 12) which demonstrate the robustness of this manufacturing approach. These CCs, additionally, display record values of $I_c(B)$ at 4.2 K (figure 12) [51]. As a counterpart, PLD growth basics are further investigated in aspects such as the modification of the growth mechanism when high pulsed laser frequencies (up to 100 Hz) are used. EUROTAPES should allow therefore to advance in achieving enhanced PLD growth rates with long lengths at a reduced cost.

The knowledge acquired in CSD YBCO growth based on Trifluoroacetate (TFA) precursors has been huge since its discovery and now a fairly good understanding of the issues associated to all the steps in growing thin films has been reached [12, 52]. For that reason now it is more and more possible to generate optimized routes to prepare CCs based on the CSD approach. Within the scope of EUROTAPES a leadership position has been generated in the use of IJD as the main tool to prepare chemical solution based CCs. There are still, however, several issues where much progress should be achieved in terms of performances. For instance, while IJD allows to achieve large film thicknesses with a single deposition, the use of this potentiality is still limited by the need to preserve a high quality and film homogeneity after the pyrolysis step which, additionally, should be as fast as possible. On the other hand, increasing the film thickness also creates new demands in terms of growth process optimization. Controlling the nucleation stage, as well as the need to increase the growth rate, raises the need to separate both

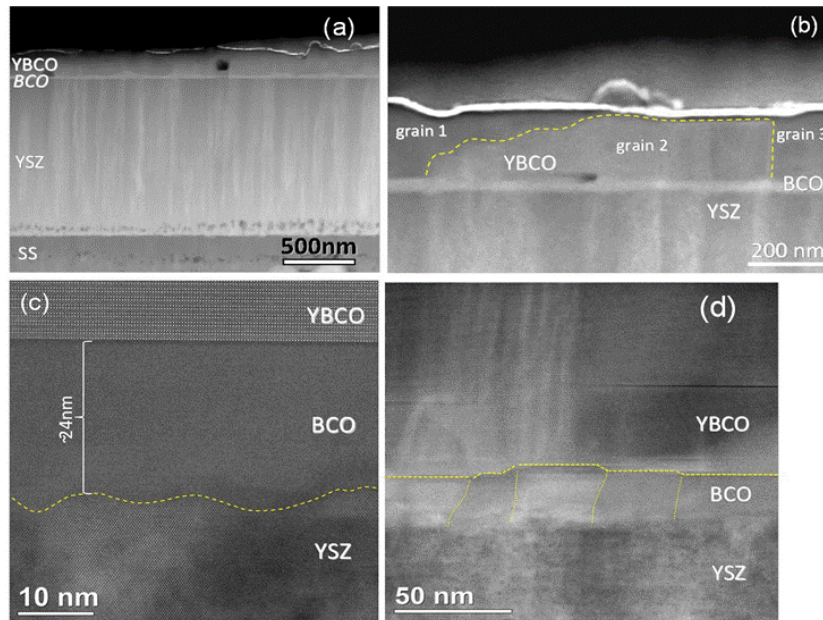

Figure 13. (a) Cross-sectional low magnification high angle annular dark field (HAADF) STEM image of a YBCO/CZO/YSZ/SS CC with a YSZ-ABAD template and YBCO and CZO films grown by CSD; (b) closer low magnification TEM image of the same sample; (c) magnified STEM image of the YSZ/BaCeO₃/YBCO interface; (d) low magnification STEM image, where the size of the BaCeO₃ grains can be observed [27].

processes and optimize them in an independent way. Within the scope of EUROTAPES the main choice is to select new metallorganic precursors to decrease the F content of the starting solutions [53, 54]. This is not only an appealing choice from an environmental point of view, it also enhances the robustness of the industrial CC production and so these precursors need to be adapted to achieve large film thickness by means of IJD. The suitability of the precursors has already been demonstrated by achieving J_c values at 77 K in excess of 3 MA cm^{-2} at self-field on single crystalline substrates [55].

In order to improve the control of the BaF₂-based processes, a useful tool has been to measure *in situ* at high temperature the electrical resistivity of the film which then allows correlating the growth rate and the oxygenation processes with external parameters [12], or to follow the complex intermediate phase transformation by means of through thickness/through time μ -Raman spectroscopy or TEM analysis of quenched films [56, 57]. The CSD approach to CC production in reel-to-reel equipments is being followed, both on RABiT substrates having PVD or CSD based buffer layers [11, 41, 58], and in ABAD-YSZ substrates with CZO buffer layers grown by CSD [27].

At the industrial level, D-Nano has already proved in Europe that IJD is a promising, reliable and low cost methodology and they are able to achieve 100 m tapes based on NiW RABiT substrates from Evico using an ‘all chemical’ approach. Very promising performances have been already demonstrated ($I_c = 160 \text{ A cm}^{-1} \text{ w}^{-1}$ in short lengths and $I_c = 105 \text{ A cm}^{-1} \text{ w}^{-1}$ in long lengths) [41]. On the other hand, the company Oxolutia has, as an alternative manufacturing approach, an IJD ‘all chemical’ multilayered architecture using ABAD-YSZ substrates provided by Bruker. Promising performances have also been demonstrated in

this case in short lengths ($I_c = 117 \text{ A cm}^{-1} \text{ w}^{-1}$) and, additionally, a strong robustness in terms of percolating current is expected after demonstrating through simultaneous evaluation of J_c^G and J_c^{GB} [27, 59] that in the YBCO film the grain size is independent of that induced by the CZO/YSZ/CC templates [27] (figure 13). Enhancing the long length production and the superconducting performances, achieving high yield, processing wider tapes, implementing film production processes with higher growth rates (and hence faster manufacturing processes), while at the same time higher I_c values are reached (through larger film thickness), are the main objectives faced by the industrial partners at present.

5. Vortex pinning strategies

After solving the grain boundary problem, the second most important boost in CC development was that of generating artificial pinning centers (APC) or non-superconducting defects through synthesis of nanocomposite materials [13–18, 60, 61]. These materials lead to a second leap in the enhancement of $J_c(H)$ curves at high temperature and definitively opened new unexplored paths in the use of superconducting materials (figures 1 and 2) which is only limited by the upper limit for the irreversibility line, associated to the loss in vortex line tension in YBCO [62].

Nanoengineering the defect structure in YBCO thin films and CCs has appeared as a formidable task and correlating the complex behavior of vortices with that nanostructure is even more tantalizing. Advances in modeling and sorting out the influence of each type of defect become possible through systematic analysis of the experimental $J_c(T, H, \theta)$ data together with advanced TEM analysis. The dimensionality, orientation and dimension of APCs have a different influence on the

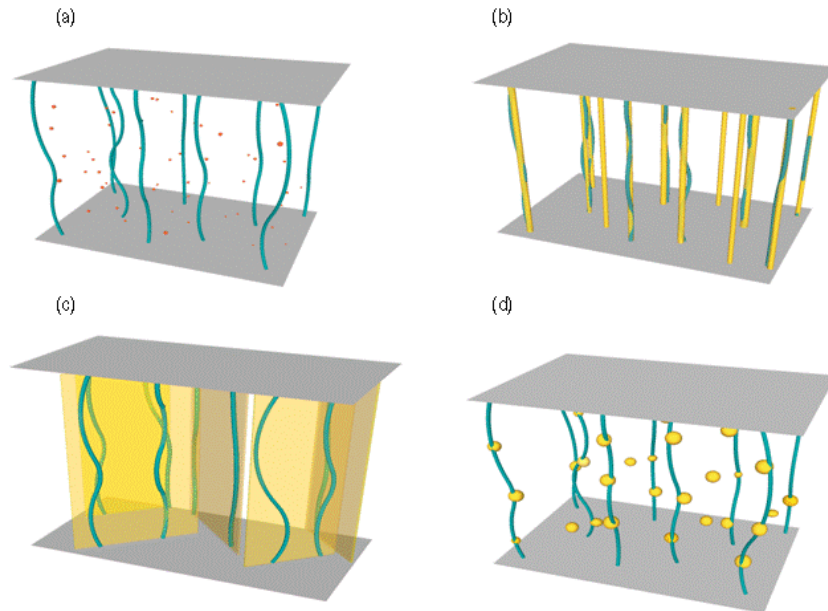

Figure 14. Sketch of the dimensionality of several artificial pinning centers (APCs) with examples of typical defects for each case. (a) OD-PC, oxygen vacancies, element substitutions, point defects (b) 1D-PC such as dislocations and columnar defects, (c) 2D-PC, like grain boundaries, twin boundaries or planar defects and (d) 3D-PC, precipitates, secondary phases or local strain [12].

critical currents (figure 14), however, very often there exist a superposition of different types of APC in the same material and so it becomes difficult to sort out the weight of isotropic and anisotropic contributions, as well as from weak and strong pinning contributions [12, 14, 15, 18, 63]. When this separation becomes possible, very useful magnetic vortex pinning phase diagrams can be generated reflecting that the influence of different APCs may strongly differ in different regions of the H - T phase diagram [12, 14, 63]. It becomes clear, therefore, that any effort directed to optimize the CCs performance must be guided by the region of the phase diagram where the corresponding power system should work (figure 3). The main efforts worldwide are devoted now, therefore, to smooth the magnetic field dependence $I_c(H)$ of CCs at different typical temperatures where the power systems working at high fields are envisaged to be developed, for instance, the 30–65 K region for high field magnets or rotating machines and the liquid He temperature for ultra-high field magnets.

The strategy to follow in developing nanocomposite CCs deeply differs depending on the growth technique. While the *in situ* growth techniques (PLD, MOCVD) rely on simultaneous nucleation and growth of the two phases coexisting in the nanocomposite, the *ex situ* growth techniques (CSD) have usually deferred nucleation processes and so the final structure of the nanocomposite completely differs. In the first case, the secondary phases keep in most cases an epitaxial relationship with the YBCO matrix and self-assembly principles determine the final nanostructure and the associated strain [64, 65]. In the second case a very significant amount of the nanoparticles is randomly oriented and hence the incoherent interfaces induce a high concentration of intergrowths in the YBCO matrix [14, 16]. This fundamental difference in the growth mechanisms and the corresponding nanostructure should be completely considered in any analysis of the vortex pinning properties

of CCs and in the definition of the strategies to follow for performance optimization. Figure 15 provides a schematic summary of the different features which clearly differentiate *in situ* from *ex situ* CC growth approaches when vortex pinning landscapes need to be compared and analyzed.

In that sense, one of the main missions of EUROTAPES is to find the best/novel sources of pinning centers that should account for the three magnetic field regimes of interest mentioned earlier (i.e. low, high field and ultra-high fields). Both technologies, PLD and CSD, are foreseen and adapted strategies are searched for. The main initial path is the nanocomposite route where nanoparticles of a non-superconducting phase are embedded in a superconducting matrix. In the PLD case, epitaxial nano-inclusions (nanoparticles, nanorods) are expected to directly account for vortex pinning and so academic and industrial partners will closely collaborate to implement them at the industrial scale [13, 15–17, 66]. On the other hand, for CSD, randomly oriented nanoparticles are searched to stimulate the generation of a 3D random network of additional defects and strain to pin vortices [14, 18, 63]. The strategy in both cases is to push nanocomposites up to the limit, evaluate their pinning strength at the different magnetic regimes and model vortex pinning to be able to further approach the depairing current limit. Advanced nanostructural analysis tools (HRTEM) and physical characterization are used to advance synergetically in understanding the properties and design the best CCs for industrial development.

A large effort has been made worldwide to gain further understanding of the self-assembly process in REBCO nanocomposites prepared by *in situ* growth techniques (PLD, MOCVD). It has been shown, actually, that vertically ordered self-assembly nanostructures is a quite extended field where many novel functionalities can be generated [66–71]. For

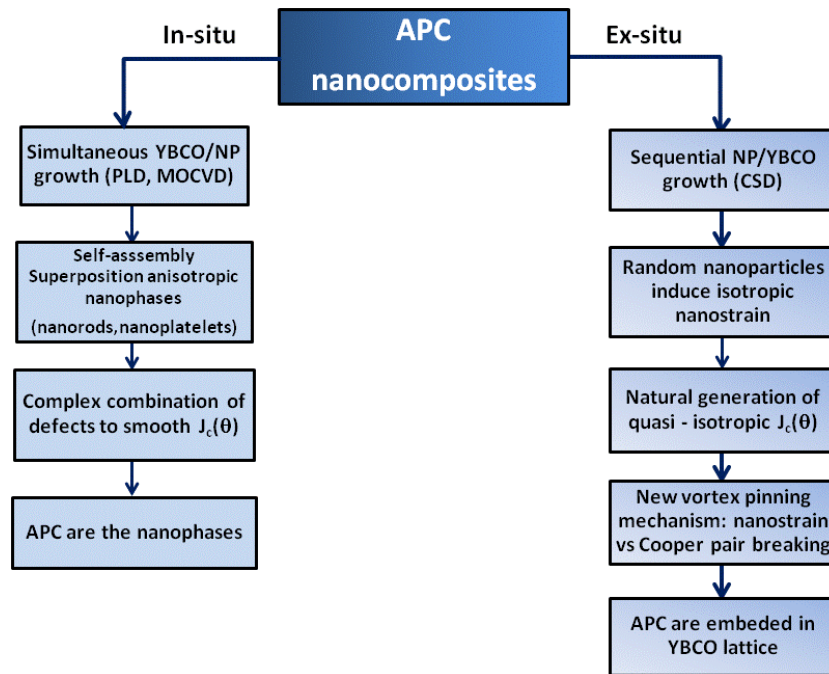

Figure 15. Schematic comparison of the issues associated to APC development based on *in situ* and *ex situ* approaches to nanocomposite films. The comparison stresses the fundamental differences existing between both approaches in terms of material development and physical phenomena involved.

instance, several authors have shown that the degree of order of the vertical self-assembled nanorods with BaMO_3 ($M = \text{Zr, Sn, Hf}$) composition may strongly differ depending on the lattice misfit with the REBCO matrix and so their efficiency as vortex pinning centers may be modified [16, 70]. These nanorods, however, increase mainly vortex pinning along a single specific direction (c -axis) and so other strategies were searched for to induce a whole increase on the $J_c(T, H, \theta)$ curves [69, 70]. The main efforts in PLD and MOCVD follow at present the idea that a synergetic behavior needs to be generated with mixed phases (for instance BaZrO_3 and Y_2O_3) introduced as APCs [16, 17, 69, 72]. The main idea behind this strategy is that nanorods enhance J_c when $H \parallel c$ while nanoplatelets are active mainly when $H \parallel ab$, therefore, if one can combine both types of nanoobjects with the correct dimensions in the same nanocomposite, smoothed $J_c(\theta)$ curves are obtained. This approach was initially discovered in YBCO-BZO nanocomposites grown at different growth rates where both nanorods and nanoparticles coexist [17]. Later it was more clearly defined when double perovskite (Ba_2YMO_6 , $M = \text{Nb, Ta}$) nanorods coexist with Y_2O_3 nanoplatelets (figure 16) [69, 72–74]. However, the complex behavior of vortices under this pinning landscape is associated to the formation of double kinks which can be arrested by the particular geometry of the inclusions and so lead to anomalous angular dependences of $J_c(\theta)$. A full analysis on the temperature-magnetic field regime where these inclusions are effective pinning centers is to be undertaken so as to foresee the need to search for other point pinning defects for ultra-high magnetic field and low temperature applications. At the same time the goal is to increase as much as possible the concentration of nanorods (to enhance the

equivalent matching field) without deteriorating T_c , an issue which appeared initially quite cumbersome [64] but which is becoming more and more controllable [75].

In CSD, the control of nanoparticles size, avoiding agglomeration and coarsening and tuning the dimensions of the induced planar defects (and so the dislocations density) are identified to be the main issues to engineer the pinning landscape at the nanoscale (figure 17). It was discovered early that BZO nanoparticles are able to strongly enhance the pinning force in CSD nanocomposites (figure 17) and this view was later extended to other perovskites such as BaHfO_3 and other REBCO compositions [14, 15, 63, 76, 77]. A recent report has analyzed many different types of nanoparticle compositions and this has allowed going well beyond the first understanding of the superconducting properties of these materials [18]. It has been recently proposed that the nanostrain generated within the YBCO lattice is the main issue responsible for the huge increase of the isotropic contribution to the observed strong pinning forces. The high interface energy between the randomly oriented nanoparticles and the YBCO lattice leads to a strong increase of the in-plane dislocation density ($\sim 1\text{--}5 \times 10^{12} \text{ cm}^{-2}$) and so the associated nanostrain. This correlation between critical currents and in-plane dislocations was actually detected early in melt textured ceramics [78]. The microscopic mechanism associating nanostrain to the APC behavior requires a fundamental understanding of the electronic mechanism underlying the Cooper pair formation [18, 79] as well as the geometrical shape of the associated APC embedded in the REBCO matrix which certainly influences the final anisotropy of $J_c(\theta)$ curves [80] and so it remains still as an open question to properly quantify this effect (figure 18).

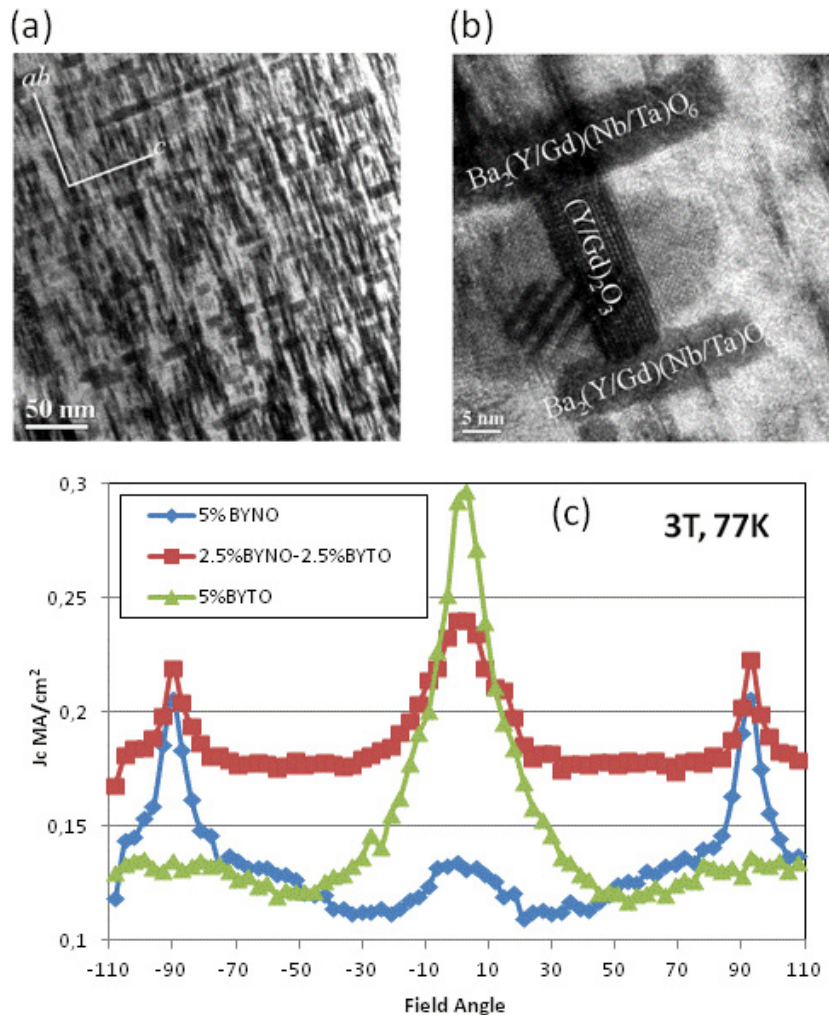

Figure 16. (a) and (b) TEM images of a YBCO nanocomposite including a mixture of Gd_3TaO_7 and Ba_2YNbO_6 where rods and plate-like nanoparticles are observed; (c) angular dependence of J_c measured at 77 K and 3 T for different nanocomposite compositions [69].

Strong efforts are being made in CSD nanocomposite development within the EUROTAPES project to modify the growth process and keep nanoparticles in small sizes (<10 nm) throughout the full heat treatment. Similar efforts are being carried out in Japan to keep reduced nanoparticle size over large film thickness [81–83]. It has now been shown that some control of the nucleation and growth of secondary phases such as Ba_2YTaO_6 (BYTO) can be reached through intermediate heat treatments which then help to keep non-agglomerated nanoparticles and so higher loads can be achieved without a decrease of the self-field J_c , an issue that clearly limits the positive effects of further enhancement of the nanostrain (figure 19) [81, 82]. It is worth mentioning as well that the nanoparticles and the planar defects deeply modify the twin boundary structure and so they influence on their vortex pinning efficiency [84].

A second route that EUROTAPES plans to implement is the pre-fabrication of nanoparticles to prepare colloidal solutions with the YBCO precursor solutions. This novel route should allow to achieve a higher control and an enhanced flexibility in designing the final nanostructure in the *ex situ* grown nanocomposites. This effort has been

pursued by many groups and researchers without success because the highly ionic and alcoholic YBCO precursor solutions induce nanoparticles precipitation, which very often are only prepared in water-based solutions. Recently, some EUROTAPES players have been successful in stabilizing some of the already synthesized nanoparticle phases in the YBCO solution and so a systematic analysis of the potential of this novel route in the growth of nanocomposites will be carried out [85, 86]. The most successful results for this effort should be then transferred to the RABITs and IBADs CCs at large thickness and long lengths. Finally, we could also mention the use of neutron irradiation as a tool to distinguish between all types of CCs among the low field regions where granularity effects are dominant from high magnetic fields where vortex pinning is enhanced by the created defects. Of course, understanding these issues is essential in order to use these materials in magnets for fusion applications [87].

6. Beyond I_c : ac losses, mechanical strength

Issues related to what has been called ‘beyond I_c ’ like filamentary conductors, Roebel conductor, ac-losses, shunt

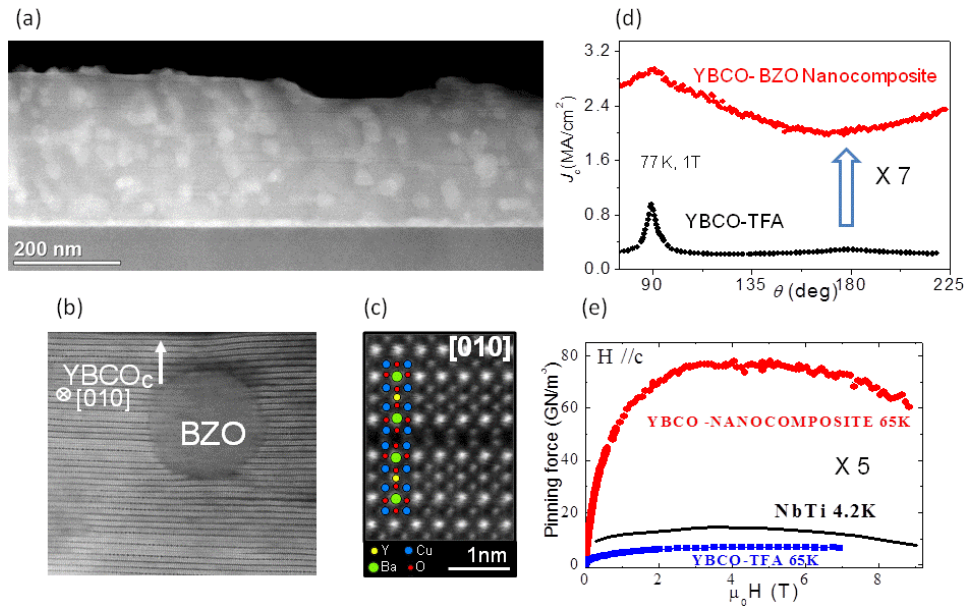

Figure 17. (a) Low-resolution cross-section TEM image of a nanocomposite film viewed along the {100} direction of YBCO where BaZrO₃ nanodots are clearly discerned. (b) Higher-magnification Z-contrast image showing the bending of the YBCO planes around the BaZrO₃ nanoparticles. A high density of intergrowths with double Cu–O chains is observed. (c) Detail of the intergrowth structure. (d) Pinning force, $F_p(H)$, curves of a nanocomposite YBCO/BZO film at 65 K, compared with a standard YBCO–TFA film at 65 K and NbTi wires at 4.2 K. (e) Anisotropy of the critical-current density, $J_c(\vartheta)$ measured at 77 K and 1 T for a nanocomposite YBCO/BZO, compared with a YBCO–TFA film [14, 18].

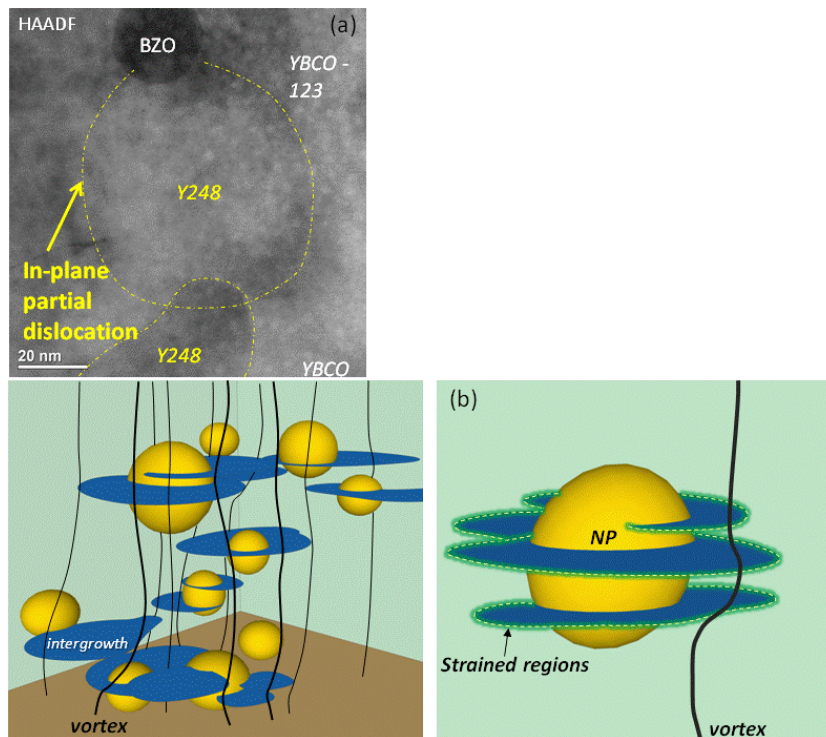

Figure 18. (a) STEM plan view micrograph of a YBCO/BZO nanocomposite obtained under low magnification Z-contrast where two intergrowth’s boundaries are identified and highlighted in yellow. (b) Sketch of the nanocomposite defect structure and the bending of vortices around the in-plane dislocations and the strained regions [18].

resistance, final conductor architecture and mechanical strength, are also very relevant issues when getting a conductor into the market, and EUROPE is working on a few of them. In

particular, ac-losses evaluation for the different architectures and scalable processes to obtain thin stripes for low ac-loss applications are also objectives of EUROTAPES [88, 89].

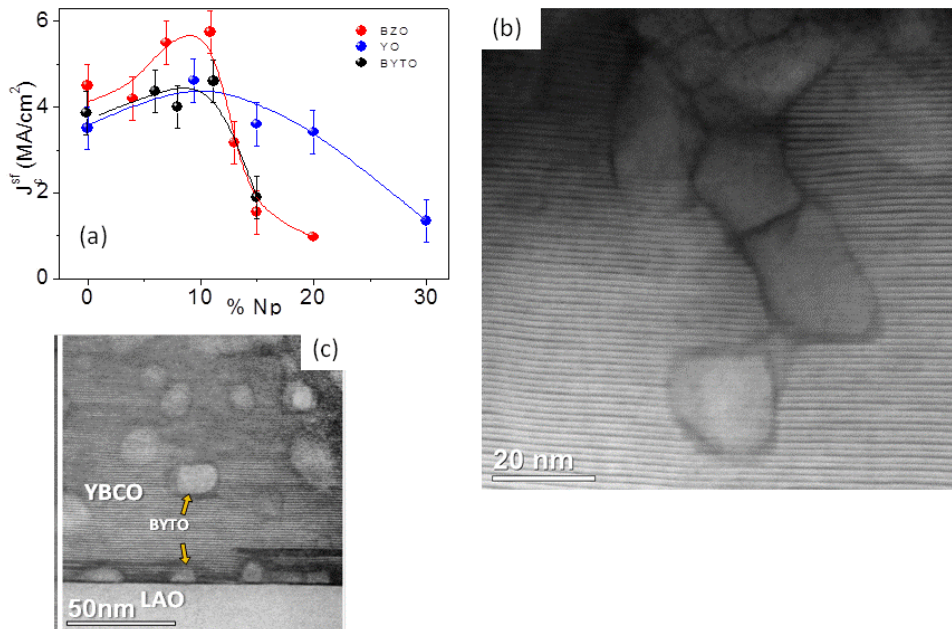

Figure 19. (a) Dependence of the self-field critical current density at 77 K, J_c^{sf} , on the nominal nanodot concentration N_p in YBCO–MO (MO = BZO, YO, BYTO) nanocomposite series. (b) High magnification Z-contrast STEM image of aggregated BYTO nanoparticles embedded in the YBCO matrix with a high density of Cu–O defects (horizontal dark stripes). (c) Z-contrast image of a YBCO–BYTO thin film with a modified thermal processing where agglomeration of the nanoparticles is avoided [81, 82].

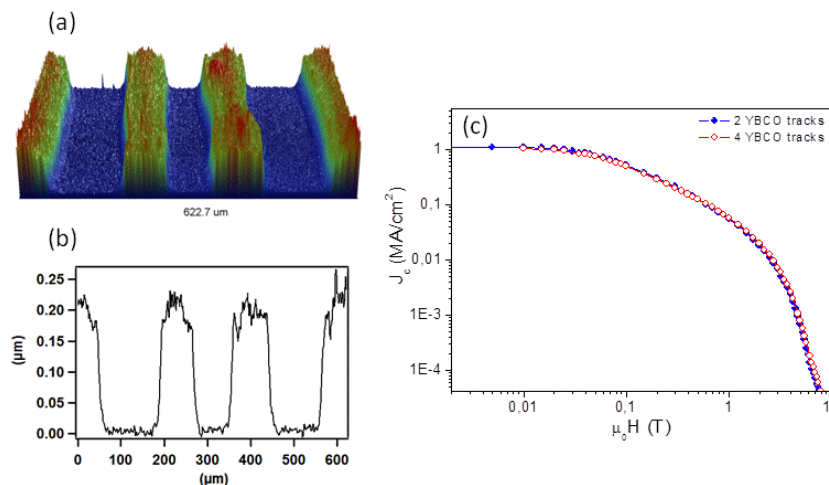

Figure 20. (a) and (b) Optical micrographs and interference profilometry profiles of YBCO patterns prepared by IJD having an average thickness of 200 nm and a width of 200 μm [41]; (c) magnetic field dependence of the critical current density (J_c) measured for two tracks (closed symbol) and four tracks (opened symbol) of YBCO films prepared by IJD; reprinted from [42], © 2013, with permission from Elsevier.

Effort is being made in the direction of using ink-jet printing methodology to grow stripes in the tapes developed in the project and evaluate the robustness of this methodology (figure 20) [41, 42]. Recent striped films prepared from TFA precursors, for instance, have shown an homogeneous behavior with $J_c > 1 \text{ MA cm}^{-2}$ at 77 K and self-field [42]. Extended work in this area relies on previous knowledge in IJD generated by several partners for the deposition of different types of functional oxides [41, 42]. Other groups in EUROPE (KIT) have reached a leadership position in using picoseconds YAG infrared lasers to generate striated strands (up to 120) which demonstrated reduced ac losses when they were used in a

transposed geometry for cables [88–90]. These strands were used to build up Roebel cables which were then assembled as Rutherford cables for fusion magnets (12 T and 50 K) and large power generators, as well as first demonstrations of structured tapes for undulators, coils and solenoids (figure 21). For instance, Roebel cables structured with 10 strands and a width of 12 mm could be tested at CERN to have self-field $I_c = 14 \text{ kA}$ at 4.2 K with a smooth magnetic field dependence $I_c(H)$ up to 10 T. These conductors also displayed robust mechanical properties: the cable withstands up to 160 MPa transverse stress. A strong effort is being made in the scope of EUROTAPES and at KIT to evaluate and model ac-losses

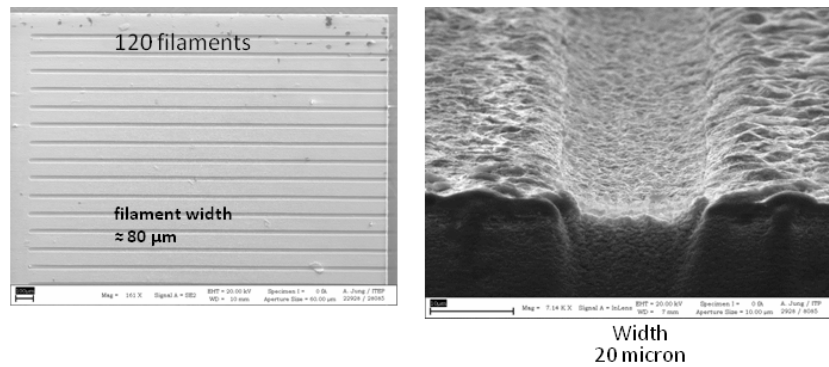

Figure 21. Image of striated CCs obtained through picosec-pulse-laser generating nearly no heat. The technique has negligible melting effects at the edges of the grooves. (Courtesy of W Goldacker *et al* [91].)

in the different conductor architectures taking into account the ferromagnetism of the different substrates and also when structured for practical applications (FCL, motors).

Additionally, other groups investigate and model the thermal stability of the conductors under diverse experimental configurations. On the other hand, the electromechanical properties are an important topic being strongly investigated in the ECCOFLOW European project devoted to FCL development. Finally, under the auspices of the European Fusion Development Agreement (EFDA), there has been deployed an activity of testing of CCs for fusion applications, i.e. mainly the determination of anisotropy of critical currents at high fields (12–16 T) and low temperature ($T \sim 20\text{--}50\text{ K}$), the electromechanical properties, ac losses analysis, thermal stabilization, study of irradiation tolerance, joint manufacturing, etc. This activity includes several different partners within Europe.

7. Power applications projects

There is a worldwide interest in integrating CCs into power systems and so there are many important running programs at present where the performances of CCs are pushed to their limits. Several summaries of the existing projects in different geographic regions have been recently reported by different authors [8, 20, 21]. Very active initiatives can be detected both in Europe and USA, but it is remarkable that a strong acceleration in the development of power applications of superconductors occurs in the Asian continent (Japan, Korea and China). Actually, as a simplified indicator, we can mention that about 2/3 of the large scale presentations in the last Applied Superconductivity Conference (Portland, USA, 2012) originated from these countries. We should also mention here that Russia has also launched an ambitious program in this area (Rosatom), running since 2010. Here we will only mention a few of the most outstanding and recent activities in the different areas, mainly within Europe.

First of all, we would like to mention the German project Ampacity, devoted to set up a 1 km ac cable together with a FCL in the city of Essen. It is a medium voltage (10 kV), three phase cable with a total power of 40 MVA. The cable is based on BSCCO 1G tape while the FCL is a resistive model built by Nexans based on bulk BSCCO ceramics. The project

is led by the utility RWE with the participation of KIT and Nexans and the cable should be installed at the end of 2013. Two other cable projects also exist in Russia corresponding to 20 kV–50 MW with a length of 200 m (ac cable) and 2.5 km (DC cable).

In the area of FCL applications there exist several projects leading to demonstrators, the most outstanding effort in Europe comes, however, from the project ECCOFLOW, led by Nexans and with 13 partners involved, 5 of them utilities. The final goal is to have a resistive FCL based on 2G CCs with the following characteristics: 24 kV and 1 kA. The demonstrator should be installed during 2014 in the grid, first in Spain, and then in Slovakia where it will become permanent. Other resistive FCL development projects are active at present in Italy and Russia based on 2G CCs and with scheduled powers of 3.4 and 2.2 MVA, respectively [20].

Concerning rotating machines there are several initiatives that are strongly active in Europe. On one hand, Siemens continues with his program of developing large synchronous machines (>4 MW). These motors are based either on 1G or 2G conductors and have been widely tested successfully. Also in Germany Ostwald Motoren has been always very active in designing and building intermediate power range motors (100–2000 kW). Finally, a new project has been recently initiated sponsored by the EU (superconducting, reliable, lightweight, and more powerful offshore wind turbine, SUPRAPOWER) to design a wind generator of 10 MW class based on MgB₂ conductors which should be cooled with cryocoolers. The project involves companies with a well established background in the wind energy sector (Acciona, Spain), tape manufacturers (Columbus, Italy) and research centers (Tecnalia, Spain, KIT, IEE Bratislava, U Southampton).

Research on the development of transformers has been maintained mainly at KIT in collaboration with ABB where a 1 MVA current limiter transformer has been demonstrated using 2G CCs. Finally, magnetic energy storage is a topic which has been investigated at CNRS Grenoble (800 kJ SMES based on BSCCO-2212) and at KIT (hybrid liquid H₂ and SMES storage based on MgB₂ wires) based on national projects.

Besides those power application projects there is a continuous development of HTS systems for use in high energy

physics, mainly led by CERN and involving several academic and industrial partners. We should particularly mention the development of current leads for LHC and high-current electrical transfer lines for the future upgrade of LHC.

Summarizing, there is around Europe a large interest in using CCs for many power and large scale applications and so it will be extremely beneficial to further develop the industrial capacity of CC manufacturing.

8. Conclusions

In conclusion, research in superconducting conductors and their applications has made huge progress since the discovery of HTS, and so now we are approaching K Onnes' dream of an extended use of superconductivity to build up a new electrical paradigm. Coated conductors based on YBCO HTS are a new enabling technology with a strong potential for the development of efficient electrical power applications which appear to be ready at the right time, just when a new sustainable energy paradigm is needed. The materials challenges faced during the last ten years have been extremely diversified, a real 'tour de force' for materials scientists and nanotechnologists, and so very imaginative ideas have been required to overcome them. The first boost in CC development was to create epitaxial multilayered architectures on metallic substrates, while the second came from the capability of creating epitaxial nanocomposite films. The main ideas and open issues concerning these developments have been reviewed with particular focus on the research and development initiatives being deployed in Europe, mainly in the scope of the EUROTAPES project. Finally, we have briefly mentioned a few outstanding power application projects based on HTS conductors to visualize the strong effort being made worldwide to integrate CCs in industrially relevant electrical energy power systems.

Acknowledgments

We acknowledge the sharing of information from: all the Eurotapes partners, Dr M Baecker from D-Nano, Professor M Noe and Dr W Goldacker from KIT, P Tixador from CNRS, Grenoble, T Arndt from Siemens, Professor J C Grivel from TU Copenhagen, Dr T Izumi from ISTE, Professor V Selvamanickham from Univ. of Houston, D Larbalestier from Tallahassee Nat. Lab., Professor K Matsumoto from Kyushu Inst. Technol. and Dr S H Moon from SuNAM. We acknowledge financial support by: MINECO (MAT2011-28874-C02, CSD2007-0041, IPT-2011-1090-920000); Generalitat de Catalunya (Pla de Recerca SGR-770 and XaRMAE); European Union (EU-FP7 NMP-LA-2012-280432 EURO-TAPES project).

References

- [1] Rogalla H and Kes P H (ed) 2011 *100 Years of Superconductivity* (London: Chapman and Hall)
- [2] Larbalestier D, Gurevich A, Feldmann D M and Polyanskii A 2001 *Nature* **414** 368
- [3] Hilgenkamp H and Mannhart J 2002 *Rev. Mod. Phys.* **74** 485
- [4] Graser S, Hirschfel P J, Kopp T, Gutser R, Andersen B M and Mannhart J 2010 *Nature Phys.* **6** 609
- [5] Feldmann D M, Holesinger T G, Feenstra R and Larbalestier D C 2008 *J. Am. Ceram. Soc.* **91** 1869
- [6] Durrell J H and Rutter N 2009 *Supercond. Sci. Technol.* **22** 013001
- [7] Obradors X *et al* 2006 *Supercond. Sci. Technol.* **19** S13
- [8] Shiohara Y, Taneda T and Yoshizumi M 2012 *Japan J. Appl. Phys.* **51** 010007
- [9] Shiohara Y, Yoshizumi M, Takagi Y and Izumi T 2013 *Physica C* **484** 1
- [10] Selvamanickam V *et al* 2013 *Supercond. Sci. Technol.* **26** 035006
- [11] Rupich M W *et al* 2010 *Supercond. Sci. Technol.* **23** 9
- [12] Obradors X, Puig T, Ricart S, Coll M, Gazquez J, Palau A and Granados X 2012 *Supercond. Sci. Technol.* **25** 123001
- [13] Macmanus-Driscoll J L, Foltyn S R, Jia Q X, Wang H, Serquis A, Civale L, Maiorov B, Hawley M E, Maley M P and Peterson D E 2004 *Nature Mater.* **3** 439
- [14] Gutiérrez J *et al* 2007 *Nature Mater.* **6** 367
- [15] Obradors X, Puig T, Palau A, Pomar A, Sandiumenge F, Mele P and Matsumoto K 2010 *Comprehensive Nanoscience and Technology* ed D Andrews, G Scholes and G Wiederrecht (Amsterdam: Elsevier) p 303
- [16] Matsumoto K and Mele P 2010 *Supercond. Sci. Technol.* **23** 014001
- [17] Maiorov B, Baily S A, Zhou H, Ugurlu O, Kennison J A, Dowden P C, Holesinger T G, Foltyn S R and Civale L 2009 *Nature Mater.* **8** 398
- [18] Llordés A *et al* 2012 *Nature Mater.* **11** 329
- [19] Nishijima S *et al* 2013 *Supercond. Sci. Technol.* **26** 113001
- [20] Tixador P 2010 *Physica C* **470** 971
- [21] Malozemoff A P 2012 *Annu. Rev. Mater. Res.* **42** 373
- [22] EUROTAPES, www.eurotapes.eu; Grant Agreement EU-FP7 NMP-LA-2012-280432
- [23] Sheehan C, Jung Y, Holesinger T, Feldmann D M, Edney C, Ihlefeld J F, Clem P G and Mathias V 2011 *Appl. Phys. Lett.* **98** 071907
- [24] Dechoux N *et al* 2012 *Supercond. Sci. Technol.* **25** 125008
- [25] Usoskin A and Kirchoff L 2009 *Mater. Res. Soc. Symp. Proc.* **1150** 117
- [26] Usoskin A and Freyhardt H C 2004 *MRS Bull.* **29** 83
- [27] Bartolomé E *et al* 2013 *Supercond. Sci. Technol.* **26** 125004
- [28] Coll M, Gazquez J, Huehne R, Holzapfel B, Morilla Y, Garcia-Lopez J, Pomar A, Sandiumenge F, Puig T and Obradors X 2009 *J. Mater. Res.* **24** 1446
- [29] Cavallaro A, Sandiumenge F, Gazquez J, Puig T, Obradors X, Arbiol J and Freyhardt H C 2006 *Adv. Funct. Mater.* **16** 1363
- [30] Hanyu S, Iijima Y, Fuji H, Kakimoto K and Saitoh T 2007 *Physica C* **463–465** 568
- [31] Hühne R, Guth K, Gartner R, Kiszun M, Thoss F, Rellinghaus B, Schultz L and Holzapfel B 2010 *Supercond. Sci. Technol.* **23** 014010
- [32] Gärtner R *et al* 2011 *IEEE Trans. Appl. Supercond.* **21** 2920
- [33] Mathias V *et al* 2010 *Supercond. Sci. Technol.* **23** 014018
- [34] Gaitzsch U, Hänisch J, Hühne R, Rodig C, Freudenberger J, Holzapfel B and Schultz L 2013 *Supercond. Sci. Technol.* **26** 085024
- [35] Eickemeyer J, Hühne R, Güth A, Rodig C, Gaitzsch U, Freudenberger J, Schultz L and Holzapfel B 2010 *Supercond. Sci. Technol.* **23** 085012
- [36] Gaitzsch U *et al* 2010 *Scr. Mater.* **62** 512

- [37] Zhao Y, Grivel J C, Liub M and Suo H 2012 *Cryst. Eng. Commun.* **14** 3089
- [38] Mos R B *et al* 2013 *Thin Solid Films* **531** 491
- [39] Petit S, Pairis S, Mikolajczyk M, Ortega L, Soubeyroux J L and Odier P 2013 *Thin Solid Films* **531** 545
- [40] Vannozzi A *et al* 2011 *IEEE Trans. Appl. Supercond.* **23** 6600505
- [41] van Driessche I *et al* 2012 *Supercond. Sci. Technol.* **25** 065017
- [42] Vilardell M, Granados X, Ricart S, van Driessche I, Palau A, Puig T and Obradors X 2013 *Thin Solid Films* **548** 489
- [43] Nagaishi T, Shingai Y, Konishi M, Taneda T, Ota H, Honda G, Kato T and Ohmatsu K 2009 *Physica C* **469** 1311
- [44] Vannozzi A, Thalmaier G, Armenio A A, Augieri A, Galluzzi V, Mancini A, Rufoloni A, Petrisor T and Celentano G 2010 *Acta Mater.* **58** 910
- [45] Kim K, Paranthaman M, Norton D P, Aytug T, Cantoni C, Gapud A A, Goyal A and Christen D K 2006 *Supercond. Sci. Technol.* **19** R23
- [46] Tokudome M, Doi T, Tomiyasu R, Sato S, Hakuraku Y, Kubota S, Shima K, Kashima N and Nagaya S 2008 *J. Appl. Phys.* **104** 103913
- [47] Roma N, Morlens S, Ricart S, Zalamova K, Moreto J M, Pomar A, Puig T and Obradors X 2006 *Supercond. Sci. Technol.* **19** 521
- [48] Holesinger T G *et al* 2008 *Adv. Mater.* **20** 391
- [49] Dürrschnabel M, Aabdin Z, Bauer M, Semerad R, Prusseit W and Eibl O 2012 *Supercond. Sci. Technol.* **25** 105007
- [50] Muydinov R Y, Stadel O and Braeuer G 2011 *IEEE Trans. Appl. Supercond.* **21** 2916
- [51] Usoskin A, Rutt A and Schlenga K 2014 in preparation
- [52] Solovoyov V, Dimitrov I K and Li Q 2013 *Supercond. Sci. Technol.* **26** 013001
- [53] Armenio A *et al* 2011 *Supercond. Sci. Technol.* **24** 115008
- [54] Chen Y, Wu C, Zhao G and You C 2012 *Supercond. Sci. Technol.* **25** 062001
- [55] Pop C, Palmer X, Ricart S, Palau A, Puig T and Obradors X 2014 in preparation
- [56] Chen Z *et al* 2010 *Supercond. Sci. Technol.* **23** 085006
- [57] Gazquez J, Sandiumenge F, Coll M, Pomar A, Mestres N, Puig T, Obradors X, Kihn Y, Casanove M J and Ballesteros C 2006 *Chem. Mater.* **18** 6211
- [58] Zhao Y, Li X F, Khoryushin A, He D, Andersen N H, Hansen B and Grivel J-C 2012 *Supercond. Sci. Technol.* **25** 015008
- [59] Palau A, Puig T, Obradors X, Pardo E, Navau C, Sánchez A, Usoskin A, Freyhardt H C, Holzapfel B and Feenstra R 2004 *Appl. Phys. Lett.* **84** 230
- [60] Wee S H, Zuev Y L, Cantoni C and Goyal A 2013 *Sci. Rep.* **3** 2310
- [61] Foltyn S R, Civale L, Macmanus-Driscoll J L, Jia Q X, Maiorov B, Wang H and Maley M 2007 *Nature Mater.* **6** 631
- [62] Figueras J, Puig T, Obradors X, Kwok W K, Paulius L, Crabtree G W and Deutscher G 2006 *Nature Phys.* **2** 402
- [63] Puig T, Gutiérrez J, Pomar A, Llordés A, Gázquez J, Ricart S, Sandiumenge F and Obradors X 2008 *Supercond. Sci. Technol.* **21** 034008
- [64] Cantoni C, Gao Y, Wee S H, Specht E D, Gazquez J, Meng J, Pennycook S J and Goyal A 2011 *ACS Nano* **5** 4783
- [65] Wee S H, Gao Y, Zuev Y L, More K L, Meng J, Zhong J, Stocks G M and Goyal A 2012 *Adv. Funct. Mater.* **23** 1912
- [66] MacManus-Driscoll J L 2010 *Adv. Funct. Mater.* **20** 2035
- [67] Harrington S A *et al* 2011 *Nature Nanotechnol.* **6** 491
- [68] Harrington S A, Durrell J H, Maiorov B, Wang H, Wimbush S C, Kursumovic A, Lee J H and MacManus-Driscoll J L 2009 *Supercond. Sci. Technol.* **22** 022001
- [69] Ercolano G, Bianchetti M, Wimbush S C, Harrington S A, Wang H, Lee J H and MacManus-Driscoll J L 2011 *Supercond. Sci. Technol.* **24** 095012
- [70] Inoue M *et al* 2011 *IEEE Trans. Appl. Supercond.* **23** 8002304
- [71] Palonen H, Jäykkä J and Paturi P 2012 *Phys. Rev. B* **85** 024510
- [72] Horide T, Kawamura T, Matsumoto K, Ichinose A, Yoshizumi M, Izumi T and Shiohara Y 2013 *Supercond. Sci. Technol.* **26** 075019
- [73] Harrington S *et al* 2010 *Nanotechnology* **21** 095604
- [74] Horide T, Kawamura T, Matsumoto M, Ichinose A, Yoshizumi A, Izumi T and Shiohara Y 2013 *Supercond. Sci. Technol.* **26** 075019
- [75] Majkic G, Yao Y, Liu J G, Liu Y H, Shi T, Chen Y M, Galstyan E, Lei C H and Selvamanickam V 2013 *IEEE Trans. Appl. Supercond.* **23** 6602605
- [76] Engel S, Thersleff T, Huhne R, Schultz L and Holzapfel B 2007 *Appl. Phys. Lett.* **90** 102505
- [77] Miura M, Maiorov B, Willis J O, Kato T, Sato M, Izumi T, Shiohara Y and Civale L 2013 *Supercond. Sci. Technol.* **26** 035008
- [78] Plain J, Puig T, Sandiumenge F, Obradors X and Rabier J 2002 *Phys. Rev. B* **65** 104526
- [79] Deutscher G 2012 *J. Appl. Phys.* **111** 112603
- [80] Beek C J, Konczykowski M and Prozorov R 2012 *Supercond. Sci. Technol.* **25** 084010
- [81] Coll M, Ye S, Rouco V, Palau A, Guzman R, Gazquez J, Arbiol J, Suo H, Puig T and Obradors X 2013 *Supercond. Sci. Technol.* **26** 015001
- [82] Coll M *et al* 2014 *Supercond. Sci. Technol.* **27** 044008
- [83] Konya K *et al* 2013 *Physica C* **494** 144
- [84] Guzman R, Gazquez J, Rouco V, Palau A, Magen C, Varela M, Arbiol J, Obradors X and Puig T 2013 *Appl. Phys. Lett.* **102** 081906
- [85] Solano E, Pérez-Mirabet L, Guzmán R, Arbiol J, Puig T, Obradors X, Yañez R, Pomar A, Ricart S and Ros J 2012 *J. Nanopart. Res.* **14** 1034
- [86] Solano E *et al* 2013 *Mater. Res. Bull.* **48** 966
- [87] Eisterer M *et al* 2010 *Supercond. Sci. Technol.* **23** 014009
- [88] Terzieva S, Vojenciak M, Pardo E, Grilli F, Drechsler A, Kling A, Kudymow A, Gomory F and Goldacker W 2010 *Supercond. Sci. Technol.* **23** 014023
- [89] Souc J, Gomory F, Kovac J, Nast R, Jung A, Vojenciak M, Grilli F and Goldacker W 2013 *Supercond. Sci. Technol.* **26** 075020
- [90] Kario A, Vojenciak M, Grilli F, Kling A, Ringsdorf B, Walschburger U, Schlachter S I and Goldacker W 2013 *Supercond. Sci. Technol.* **26** 085019
- [91] Goldacker W *et al* 2014 in preparation